

kons MIA

pendant, wall and table lamp

filumen®

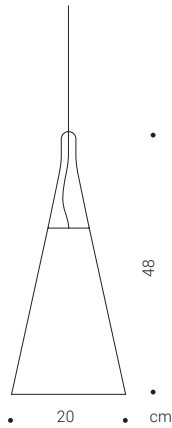

Description

MIA is convincing with multiple colours and numerous uses as a pendant, wall and table lamp. The pendant light comes with a hook and canopy. The wall lamp has a wooden knob and a textile cable with a switch. Optionally, the wall lamp can be expanded to a table lamp with the pluggable MIA base.

Shade

Fabric shade chintz (see colour chart)

Frame

Black matt

Dimensions (dxh)

Ø 20 x 48 cm

Supply cable

Textile cable, black

Light source

E27 max. A60 / 800lm

Energy class

A–D (depends on the light source)

Type of protection

IP20

Protection class

II

Mains voltage

220-240V 50/60Hz

Net weight

0,38 kg

Packing volume

0,031 m³

Options

Special colours

Certificates



Design

2015, Christian Finke



Model

MIA P

Pendant lamp

MIA W

Wall light

MIA T

Base, pluggable

Type

External

On/Off

(expansion for

Switch

ca.200 cm

ca.180 cm

wall lamp)

Cable

Plastic black

–

Canopy

MIA P

MIA W

MIA_T_BASE

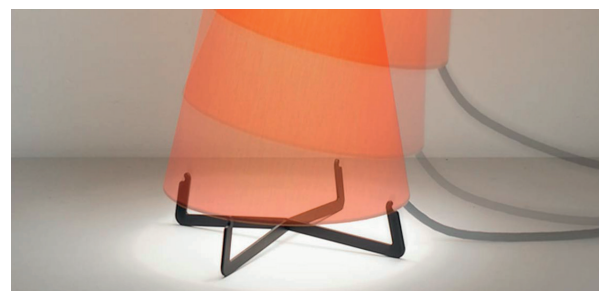

kons
MINA
wall lamp

filumen®

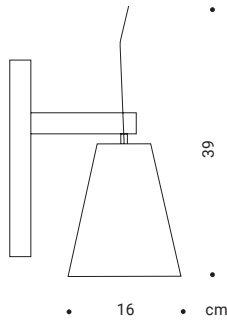

Description

The MINA wall light with a moveable shade is particularly suitable as a glare-free reading light. The solid oak arm, untreated or black lacquered, is as honest as it is simple. The basic version has a textile cable with a switch. If a wall outlet and external circuit are planned, the power cord can also be concealed.

Shade

Fabric shade chintz (see colour chart), inside white or gold

Mounting arm

Oak, nature or black finishing

Dimensions (dxhxt)

Ø 16 x 39 x 23 cm

Supply cable

Textile Cable black ca.180 cm

Switch

ON/OFF

Light source

E27 max. A40 / 470lm

Energy class

A–D (depends on light source)

Type of protection

IP20

Protection class

II

Mains voltage

220-240V 50/60Hz

Net weight

0,54 kg

Packing volume

0,021 m³

Options

Shade inside gold, concealed cable routing, special colours

Certificates



Design

2018, Christian Finke



Model

MINA

Base material

Oak nature

Oak, black finished

Shade colour

See colour chart

See colour chart

Order Code:

MINA W_N

MINA W_B

Shade inside

white

gold



Mounting arm

nature

black

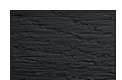

kons
LEA LED
 pendant & ceiling lamp

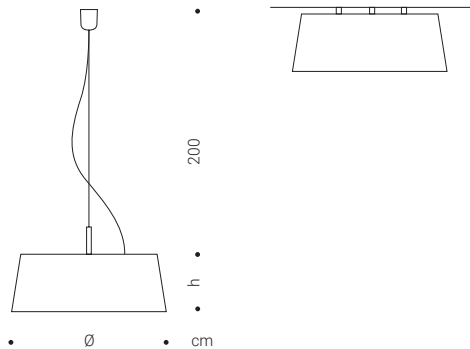

Description

The LEA with permanently installed LED technology is available as a pendant and a ceiling lamp. The shade of the pendant version is designed with a black top and a small light gap. The ceiling lamp is mounted at a slight distance from the ceiling. Optionally, the lamps can be ordered with a matt gold inner foil. The PC diffuser on the underside can be removed without using tools. With the AC version, the cable is centrally placed. The DC version comes with steel cable suspension and an off-centre supply cable.

Shade

Fabric shade chintz, white or gold inside, (see colour chart)

Diffuser

Polycarbonate foil, suspended on underside

Supply cable

Textile cable grey, approx. 200 cm

Type of protection

IP20

Mains voltage

220-240V 50/60Hz

Light distribution

Directional

Options

Gold foil, special dimensions, special materials, fire protection B1

Certificates



Design

2018, Christian Finke

Shade inside:

white gold



Model

LEA 25

LEA 35

LEA 46

Dimensions (dxh)

ø 25 x 11 cm

ø 35 x 14 cm

ø 46 x 16,5 cm

Lighting technology

AC LED module
2200lm

DC LED Dali
2000lm

AC LED module
3500lm

DC LED Dali
2800lm

AC LED module
4660lm

DC LED Dali
3700lm

Power

P=20W

P=13W

P=30W

P=21,4W

P=42W

P=25W

Luminous efficacy

110 lm/W

154 lm/W

117 lm/W

130 lm/W

110 lm/W

148 lm/W

Light colour / CRI

3000°K / >80RA

2700°K / >90RA

3000°K / >80RA

2700°K / >90RA

3000°K / >80RA

2700°K / >90RA

Electr. regulation

Triac

Dali

Triac

Dali

Triac

Dali

Lifetime

min. 50.000h

min. 50.000h

min. 50.000h

min. 50.000h

min. 50.000h

min. 50.000h

Protection class

II

I

II

I

II

I

Energy class

A+

A+

A+

A+

A+

A+

Net weight

0,68 kg

0,9 kg

1,18 kg

1,9 kg

2,25 kg

2,9 kg

Packing volume

0,017 m³

0,017 m³

0,038 m³

0,038 m³

0,08 m³

0,08 m³

Order code:

Pendant lamp

LEA 25_P_ACL

LEA 25_P_DCL_D

LEA 35_P_ACL

LEA 35_P_DCL_D

LEA 46_P_ACL

LEA 46_P_DCL_D

Ceiling lamp

LEA 25_M_ACL

LEA 25_M_DCL_D

LEA 35_M_ACL

LEA 35_M_DCL_D

LEA 46_M_ACL

LEA 46_M_DCL_D

kons
LEA E14/27
 pendant lamp

filumen®

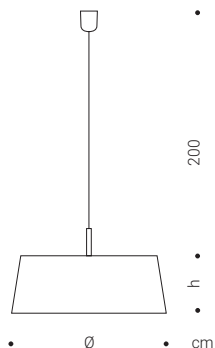

Description	LEA with classic screw socket is suitable as a pendant lamp at eye-level height. The shades are open at the top and bottom. Optionally, the lamp can be ordered with matt gold inner foil and fittings in black or white.
Shade	Chintz, white or gold inside, without diffuser (see colour chart).
Supply cable	Textile cable grey, approx. 200 cm, centric
Electrical regulation	Depending on bulb
Type of protection	IP20
Mains voltage	220-240V 50/60Hz
Light distribution	Directional
Options	Gold foil inside, special dimensions, special materials, fire protection class B1
Certificates	
Design	2018, Christian Finke

Model	LEA 25	LEA 35	LEA 46
Dimension (dxh)	ø 25 x 11 cm	ø 35 x 14 cm	ø 46 x 16,5 cm
Lighting technology	E14 max. A40 470lm	E27 max. A100 1500lm	E27 max. A100 1500lm
Protection class	II	II	II
Energy class	depends on light	depends on light	depends on light
Net weight	0,7 kg	0,85 kg	1,2 kg
Packing volume	0,014 m³	0,03 m³	0,053 m³
Order code:	LEA 25_P_E14	LEA 35_P_E27	LEA 46_P_E27

Shade inside

white gold



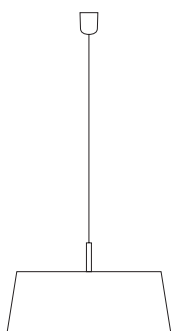

LEA

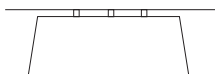

LEA M

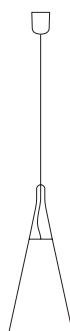

MIA P

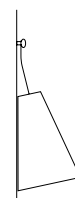

MIA W



MIA T



MINA

KONS

CHINTZ

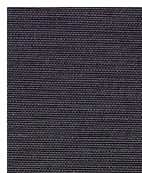

coffee #20



anthracite #13



stone-grey #18



light-grey #12



white #22



mustard #23



kiwi #15



olive #21



beige #14



flamingo #19



coral #17

INSIDE

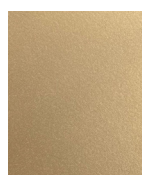

PVC gold

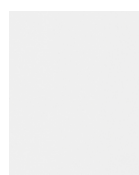

PVC white

The fabric samples shown here are only approximations. Real samples can be viewed at our retail stores.